

REV.	ECN NO.	DESCRIPTION	DESIGN	DATE
A		INITIAL	Kai	2018.03.29

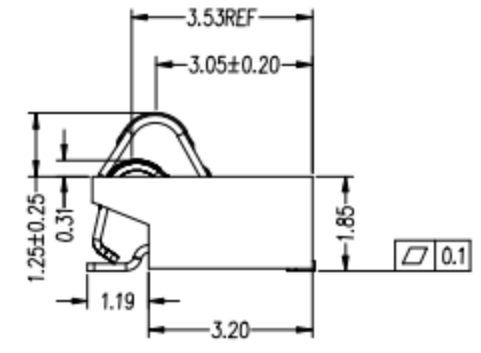

Pin(N)	DIMA	DIMB	DIMC
3Pin	4.80	3.20	0
4Pin	6.40	4.80	0
5Pin	8.00	6.40	3.20
6Pin	9.60	8.00	4.80
7Pin	11.20	9.60	6.40
8Pin	12.80	11.20	8.00
9Pin	14.40	12.80	9.60
10Pin	16.00	14.40	11.20

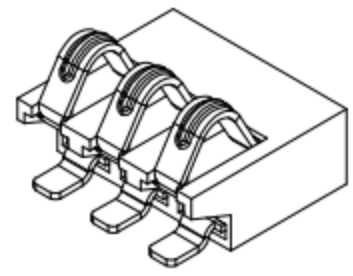
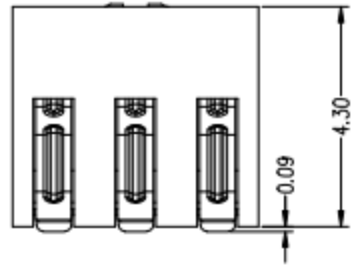
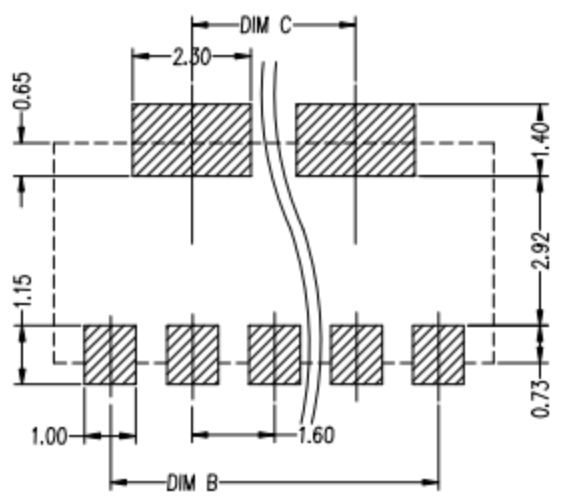
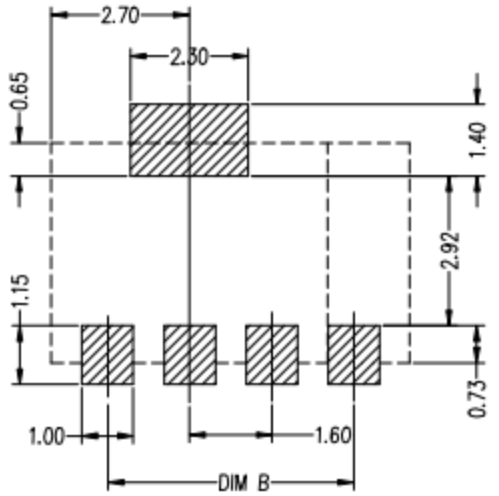
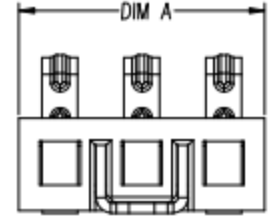
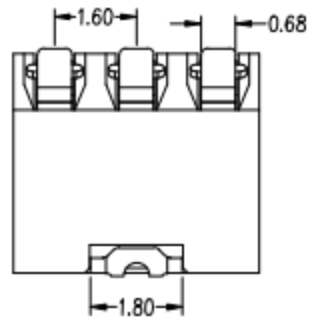
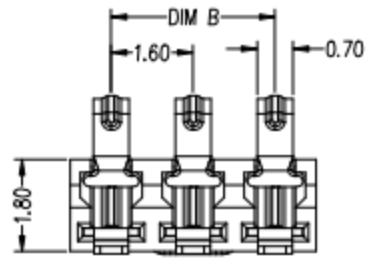

3&4PIN LAYOUT  
RECOMMENDED PCB LAYOUT  
TOL:(±0.05)

**性能:**  
 额定电流: 2.0A  
 额定电压: 12V  
 耐电压: 500V  
 接触电阻: 30mΩ  
 绝缘电阻: 500MΩ  
 工作温度: -40℃~+85℃  
 塑件(材质): LCP  
 接触点(材质): 磷铜, 镀金

UNLESS OTHERWISE SPECIFIED TOLERANCES

DECIMALS:		ANGLES:	
DIM	TOL	DIM	TOL
X.	±0.50	X.	±2°
X.X	±0.30	X.X	±1°
X.XX	±0.20	X.XX	-----
X.XXX	±0.10	X.XXX	-----

**东莞市高迪电子有限公司**

DWG NO.	PART NAME:
DESIGN:	PART NO.
CHECK:	REV. A
APPROVED	UNIT: mm
	SHEET: 1/1

ITEM	PART NAME	Q'TY	MATERTAL	DESCRIPTION	REMARK
②	HOUSING	1	LCP		BLACK
①	CONTACT A	2	PHOSPHOR BRONZE 0.20T	Au PLATED	